

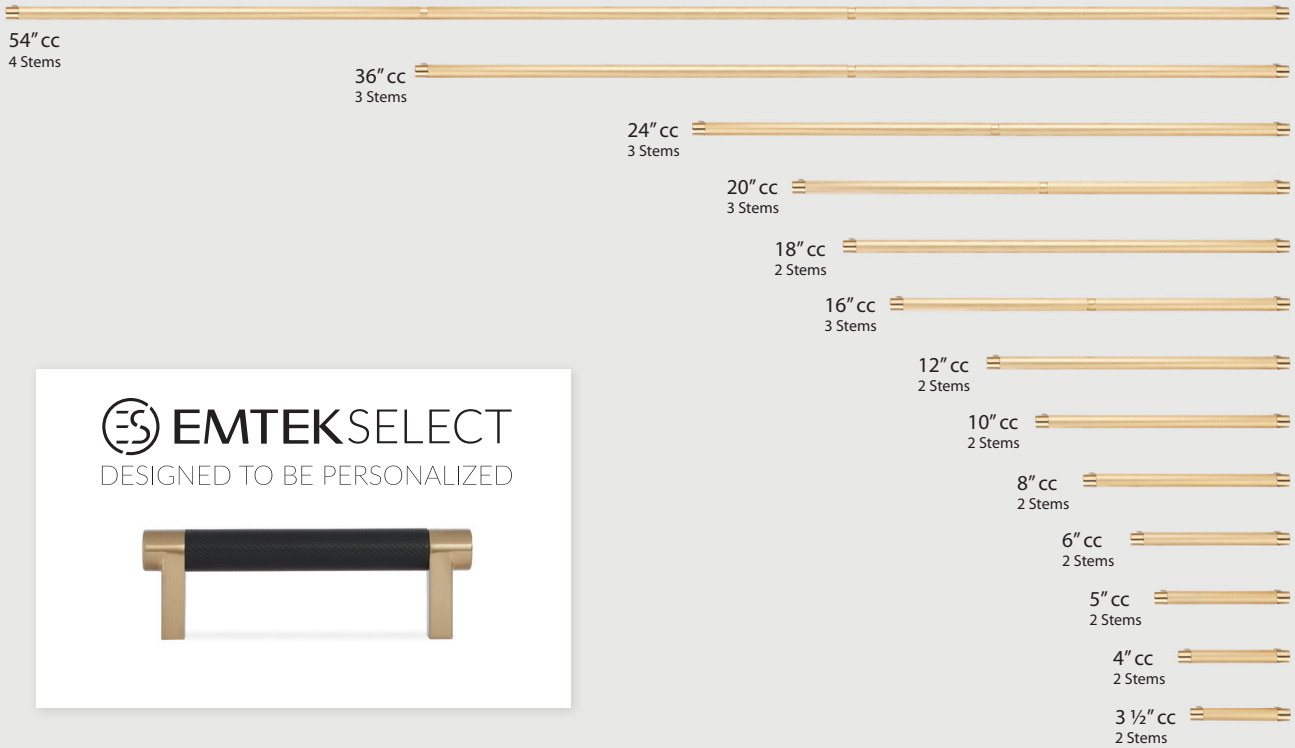



SELECT CABINET PULL



SELECT CABINET PULL

Product Code	C-To-C	Overall	Width(W)	Projection(P)	Stem
84052	3 1/2"	4 1/4"	1/2"	1 3/8"	2
84053	4"	4 3/4"	1/2"	1 3/8"	2
84054	5"	5 3/4"	1/2"	1 3/8"	2
84055	6"	6 3/4"	1/2"	1 3/8"	2
84056	8"	8 3/4"	1/2"	1 3/8"	2
84057	10"	10 3/4"	1/2"	1 3/8"	2
84058	12"	12 3/4"	1/2"	1 3/8"	2
84059	16"	16 3/4"	1/2"	1 3/8"	3
84062	18"	18 3/4"	1/2"	1 3/8"	2
84060	20"	20 3/4"	1/2"	1 3/8"	3
84061	24"	24 3/4"	1/2"	1 3/8"	3
84063	36"	36 3/4"	1/2"	1 3/8"	3
84064	54"	54 3/4"	1/2"	1 3/8"	4

Stem	Pull
 RECTANGULAR (REC)	 KNURLED (KN)  SMOOTH (SM)

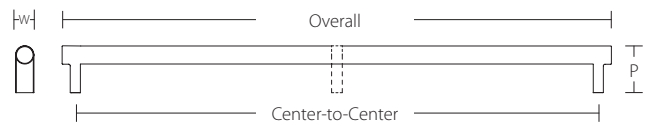

FINISH OPTIONS FOR STEM AND PULL



STEM AND PULL WILL BE PERMANENTLY AFFIXED.

To order:

84052 . RECUS4 . KNUS19

Product Code (Center-to-Center) + Stem (Style/Finish) + Pull (Style/Finish)

Product Name:
 SELECT Cabinet Pull 3-1/2" C-to-C + Rectangular Stem
 Satin Brass (US4) + Knurled Pull Flat Black (US19)

SELECT BAR CABINET PULL

54" CC
4 Stems

36" CC
3 Stems

24" CC
3 Stems

20" CC
3 Stems

18" CC
2 Stems

16" CC
3 Stems

12" CC
2 Stems

10" CC
2 Stems

8" CC
2 Stems

6" CC
2 Stems

5" CC
2 Stems

4" CC
2 Stems

3 1/2" CC
2 Stems

ES **EMTEKSELECT**
DESIGNED TO BE PERSONALIZED



SELECT BAR CABINET PULL

Product Code	C-To-C	Overall	Width(W)	Projection(P)	Stem
84152	3 1/2"	5 3/4"	1/2"	1 3/8"	2
84153	4"	6 1/4"	1/2"	1 3/8"	2
84154	5"	7 1/4"	1/2"	1 3/8"	2
84155	6"	8 1/4"	1/2"	1 3/8"	2
84156	8"	10 1/4"	1/2"	1 3/8"	2
84157	10"	12 1/4"	1/2"	1 3/8"	2
84158	12"	14 1/4"	1/2"	1 3/8"	2
84159	16"	18 1/4"	1/2"	1 3/8"	3
84162	18"	20 1/4"	1/2"	1 3/8"	2
84160	20"	22 1/4"	1/2"	1 3/8"	3
84161	24"	26 1/4"	1/2"	1 3/8"	3
84163	36"	38 1/4"	1/2"	1 3/8"	3
84164	54"	56 1/4"	1/2"	1 3/8"	4

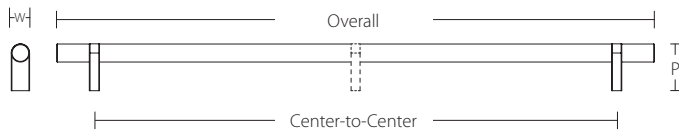

Stem



Pull



FINISH OPTIONS FOR STEM AND PULL



Satin Brass (US4)



Oil Rubbed Bronze (US10B)



Polished Nickel (US14)



Satin Nickel (US15)



Flat Black (US19)



Polished Chrome (US26)



Satin Copper (SCU)

STEM AND PULL WILL BE PERMANENTLY AFFIXED.

To order:

84152 . RCBUS4 . KNUS19

Product Code
(Center-to-Center)

+

Stem
(Style/Finish)

+

Pull
(Style/Finish)

Product Name:



SELECT Bar Cabinet Pull 3-1/2" C-to-C + Rectangular Bar Stem Satin Brass (US4) + Knurled Pull Flat Black (US19)

SELECT APPLIANCE PULL



EMTEK SELECT
DESIGNED TO BE PERSONALIZED

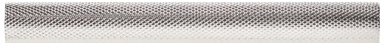

SELECT APPLIANCE PULL							Stem	Pull
Optional Mounting	Product Code	C-to-C	Overall	Width(W)	Projection(P)	Stem		
CS or BTB	84070	12"	13"	7/8"	2 1/8"	2	 RECTANGULAR (REC)	 KNURLED (KN)
CS or BTB	84071	18"	19"	7/8"	2 1/8"	2		 SMOOTH (SM)
CS or BTB	84072	24"	25"	7/8"	2 1/8"	3		
CS or BTB	84073	36"	37"	7/8"	2 1/8"	3		
CS or BTB	84074	54"	55"	7/8"	2 1/8"	4		

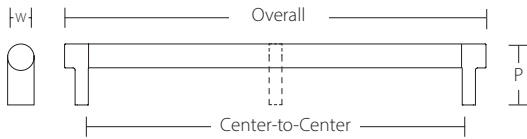

FINISH OPTIONS FOR STEM AND PULL

STEM AND PULL WILL BE PERMANENTLY AFFIXED.



Satin Brass (US4)



Oil Rubbed Bronze (US10B)



Polished Nickel (US14)



Satin Nickel (US15)



Flat Black (US19)



Polished Chrome (US26)



Satin Copper (SCU)

To order: **CS/BTB** **84070** . **RECUS4** . **KNUS19**

Optional Mounting or Leave Blank for Standard Mounting Product Code (Center-to-Center) + Stem (Style/Finish) + Pull (Style/Finish)

Product Name:
SELECT Cabinet Appliance Pull 12" C-to-C + Rectangular Stem Satin Brass (US4) + Knurled Pull Flat Black (US19)

Standard Mounting

Thru-Bolt with Decorative Caps

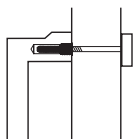

Optional Mounting

Concealed Surface CS

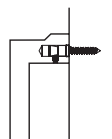

Back-to-Back BTB

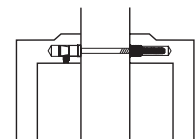

SELECT BAR APPLIANCE PULL



SELECT BAR APPLIANCE PULL							Stem	Pull
Optional Mounting	Product Code	C-to-C	Overall	Width(W)	Projection(P)	Stem		
CS or BTB	84170	12"	15 1/8"	7/8"	2 1/8"	2	<p>RECTANGULAR BAR (RCB)</p>	<p>KNURLED (KN)</p>
CS or BTB	84171	18"	21 1/8"	7/8"	2 1/8"	2		
CS or BTB	84172	24"	27 1/8"	7/8"	2 1/8"	3		
CS or BTB	84173	36"	39 1/8"	7/8"	2 1/8"	3		
CS or BTB	84174	54"	57 1/8"	7/8"	2 1/8"	4		

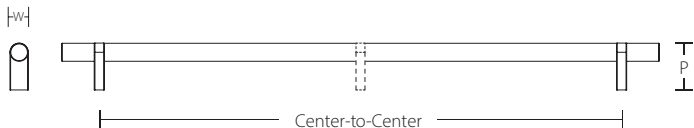

FINISH OPTIONS FOR STEM AND PULL							STEM AND PULL WILL BE PERMANENTLY AFFIXED.	
Satin Brass (US4)	Oil Rubbed Bronze (US10B)	Polished Nickel (US14)	Satin Nickel (US15)	Flat Black (US19)	Polished Chrome (US26)	Satin Copper (SCU)		

To order: **CS/BTB 84170** . **RCBUS4** . **KNUS19**

Optional Mounting or Leave Blank for Standard Mounting Product Code (Center-to-Center) + Stem (Style/Finish) + Pull (Style/Finish)

Product Name:
SELECT Bar Cabinet Appliance Pull 12" C-to-C + Rectangular Bar Stem Satin Brass (US4) + Knurled Pull Flat Black (US19)

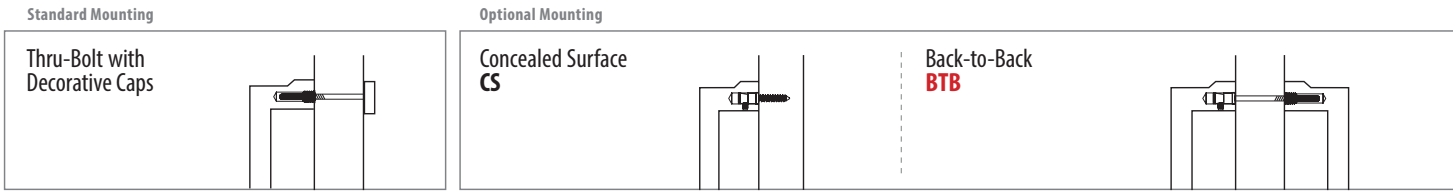

SELECT CABINET KNOB



SELECT CABINET KNOB			Stem	Knob
Product Code	Dimension(D)	Projection(P)		
86655	1 1/4"	1"		
			<p>CONICAL (CCK)</p>	<p>KNURLED (KNK)</p> <p>SMOOTH (SMK)</p>

FINISH OPTIONS FOR STEM AND KNOB

STEM AND KNOB WILL BE PERMANENTLY AFFIXED.



Satin Brass
(US4)



Oil Rubbed Bronze
(US10B)



Polished Nickel
(US14)



Satin Nickel
(US15)



Flat Black
(US19)



Polished Chrome
(US26)



Satin Copper
(SCU)

To order:

86655 . CCKUS4 . KNKUS19

Product Code

+

Stem

(Style/Finish)

+

Knob



(Style/Finish)

Product Name:

SELECT Cabinet Knob 1-1/4" + Conical Stem Satin Brass (US4)
+ Knurled Knob Handle Flat Black (US19)

SELECT CABINET EDGE PULL



SELECT CABINET EDGE PULL					Stem	Pull
Product Code	C-to-C	Overall	Width	Projection(P)		
84080	3 3/4"	4 1/2"	1/8"	2 1/4"	 ROUND (EDGR)	 KNURLED (KN)
84081	4 1/4"	5"	1/8"	2 1/4"		
84082	5 1/4"	6"	1/8"	2 1/4"		
84083	6 1/4"	7"	1/8"	2 1/4"		
84084	8 1/4"	9"	1/8"	2 1/4"		
84085	10 1/4"	11"	1/8"	2 1/4"		
84086	12 1/4"	13"	1/8"	2 1/4"		
84087	18 1/4"	19"	1/8"	2 1/4"		

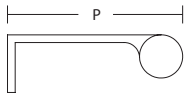

FINISH OPTIONS FOR STEM AND PULL

STEM AND PULL WILL BE PERMANENTLY AFFIXED.



Satin Brass (US4)



Oil Rubbed Bronze (US10B)



Polished Nickel (US14)



Satin Nickel (US15)



Flat Black (US19)



Polished Chrome (US26)



Satin Copper (SCU)

To order:

84080 . EDGRUS4 . KNUS19

Product Code
(Center-to-Center)

+

Stem
(Style/Finish)

+

Pull
(Style/Finish)

Product Name:

SELECT Cabinet Edge Pull 3-3/4" C-to-C + Round Stem
Satin Brass (US4) + Knurled Pull Flat Black (US19)

SELECT CABINET T-KNOB & FINGER PULL

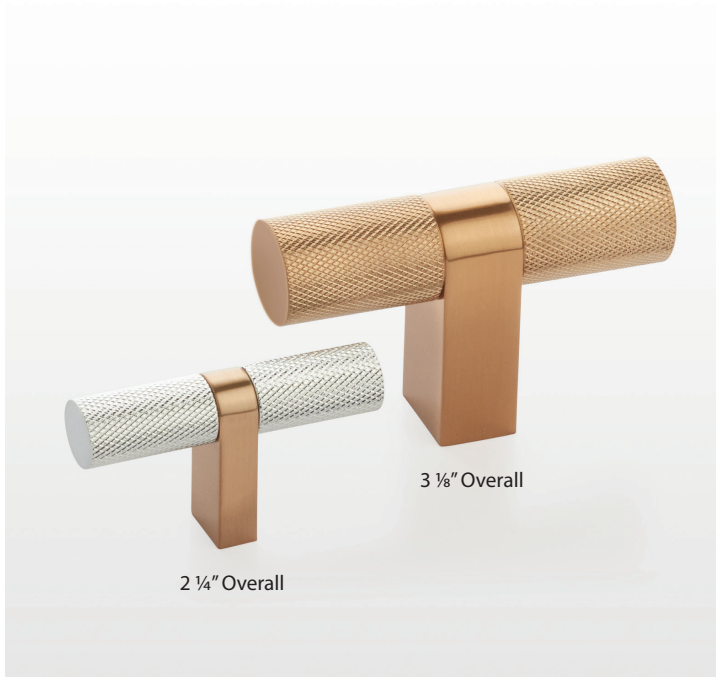

SELECT CABINET T-KNOB				Stem	Pull
Product Code	Overall	Width(W)	Projection(P)	<p>RECTANGULAR BAR (RCB)</p>	<p>KNURLED (KN)</p> <p>SMOOTH (SM)</p>
86656	2 1/4"	1/2"	1 3/8"		
86657	3 1/8"	7/8"	2 1/8"		
				STEM AND PULL WILL BE PERMANENTLY AFFIXED.	

SELECT CABINET FINGER PULL				Stem	Pull
Product Code	Overall	Width(W)	Projection(P)	<p>RECTANGULAR (REC)</p>	<p>KNURLED (KN)</p> <p>SMOOTH (SM)</p>
86658	1 1/2"	1/2"	1 3/8"		
86659	2"	7/8"	2 1/8"		
				STEM AND PULL WILL BE PERMANENTLY AFFIXED.	

FINISH OPTIONS FOR STEM AND PULL



To order:

86656 . **RCBUS4** . **KNUS19**

Product Code

+

Stem
(Style/Finish)

+

Pull
(Style/Finish)

Product Name:

SELECT Cabinet T-Knob 2-1/4" Overall + Rectangular Bar
Stem Satin Brass (US4) + Knurled Pull Flat Black (US19)